

Verschlüsse mit Feder  
 Clasps with spring  
 Fermeoirs avec ressort  
 Cierres con resorte  
 Fermagli con molla

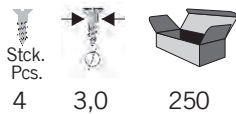

1321- 2985.02. =

Stck.  
Pcs.  
4 3,0 250

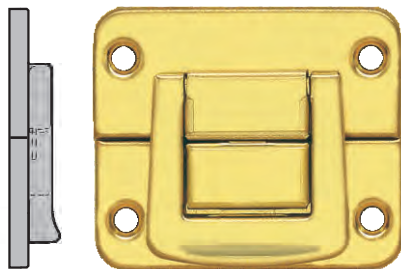
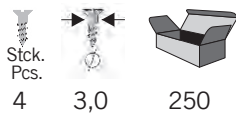
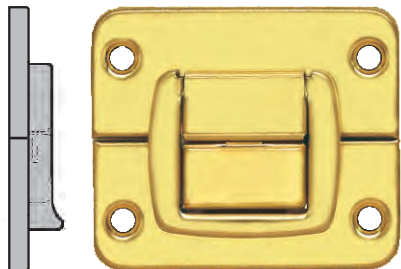

1321- 3001.02. =

Stck.  
Pcs.  
4 3,0 250

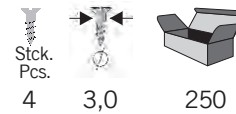
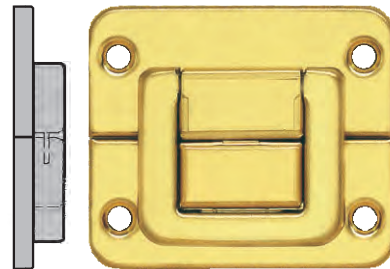

1321- 3033.02. =

Stck.  
Pcs.  
4 3,0 250

Passende Befestigungsmittel finden Sie in Kataloggruppe 26  
 Please find the respective fastening equipment in our catalogue group 26  
 Vous trouverez le matériel de fixation correspondant dans le groupe 26 du catalogue  
 Vds, encontrarán el material de fijación correspondiente en el grupo 26 del catálogo  
 Materiale appropriato per fissaggio corrispondente al gruppo 26 del catalogo



Weitere Varianten auf Anfrage  
 Other variations available upon enquiry  
 Autres variantes sur demande  
 Más variantes a pedido del cliente  
 Altre varianti su richiesta

natürliche Größe  
 actual size  
 grandeur naturelle  
 tamaño natural  
 grandezza naturale

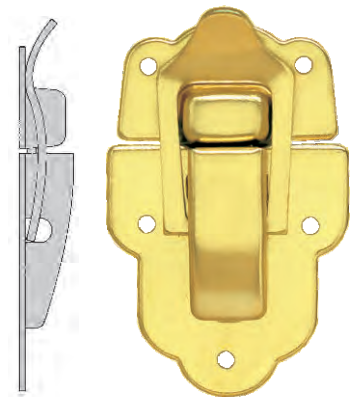
Verschlüsse mit Feder  
Clasps with spring  
Ferroirs avec ressort  
Cierres con muelle  
Fermagli con molla



1331- 1272.00.

		
Stck. Pcs.	∅	
5	1,8	500

Passende Befestigungsmittel finden Sie in Kataloggruppe 26  
Please find the respective fastening equipment in our catalogue group 26  
Vous trouverez le matériel de fixation correspondant dans le groupe 26 du catalogue  
Vds. encontrarán el material de fijación correspondiente en el grupo 26 del catálogo  
Materiale appropriato per fissaggio corrispondente al gruppo 26 del catalogo

Weitere Varianten auf Anfrage  
Other variations available upon enquiry  
Autres variantes sur demande  
Más variantes a pedido del cliente  
Altre varianti su richiesta

natürliche Größe  
actual size  
grandeur naturelle  
tamaño natural  
grandezza naturale

Schiebeverschlüsse  
 Slide locks  
 Fermeurs poussoirs  
 Cierres corredizos  
 Serrature a cursore



 enthalten  
 included

1352- 1857.6-



Stck. Pcs. 4 2,0 250



1352- 2966.2-



Stck. Pcs. 4 2,0 1000



1352- 2967.2-



Stck. Pcs. 4 2,0 1000

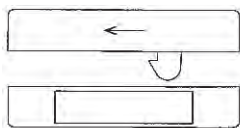

1352- .....1

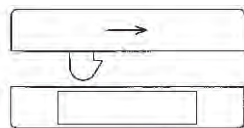

1352- .....2

lieferbar	(.-1.)	links oder	(.-2.) rechts
available	(.-1.)	left or	(.-2.) right
livrable	(.-1.)	gauche ou	(.-2.) droite
entregable	(.-1.)	izquierda o	(.-2.) derecha
fornibili	(.-1.)	a sinistra o	(.-2.) destra

Passende Befestigungsmittel finden Sie in Kataloggruppe 26  
 Please find the respective fastening equipment in our catalogue group 26  
 Vous trouverez le matériel de fixation correspondant dans le groupe 26 du catalogue  
 Vds, encontrarán el material de fijación correspondiente en el grupo 26 del catálogo  
 Materiale appropriato per fissaggio corrispondente al gruppo 26 del catalogo

Weitere Varianten auf Anfrage  
 Other variations available upon enquiry  
 Autres variantes sur demande  
 Más variantes a pedido del cliente  
 Altre varianti su richiesta

natürliche Größe  
 actual size  
 grandeur naturelle  
 tamaño natural  
 grandezza naturale

Verschlüsse mit Riegel oder Bügel  
 Clasps with bolt or bow  
 Fermeoirs à verrou ou à boucle  
 Cierres con pestillo o gancho  
 Fermagli con gancio o a staffa

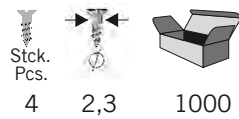

1362- 2968.21. =

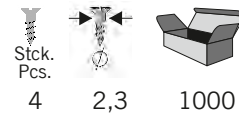

1362- 2968.22. =

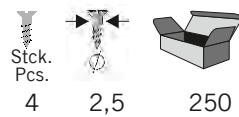

1363- 2933.20. =

Passende Befestigungsmittel finden Sie in Kataloggruppe 26  
 Please find the respective fastening equipment in our catalogue group 26  
 Vous trouverez le matériel de fixation correspondant dans le groupe 26 du catalogue  
 Vds. encontrarán el material de fijación correspondiente en el grupo 26 del catálogo  
 Materiale appropriato per fissaggio corrispondente al gruppo 26 del catalogo

Weitere Varianten auf Anfrage  
 Other variations available upon enquiry  
 Autres variantes sur demande  
 Más variantes a pedido del cliente  
 Altre varianti su richiesta

natürliche Größe  
 actual size  
 grandeur naturelle  
 tamaño natural  
 grandezza naturale